

EOS 14.0

Colonne di segnalazione LED con standard di comunicazione analogico

#morethanbrightideas

Per ulteriori informazioni contattaci o visita il nostro sito

industrial@sirena.it



EOS 14.0

Il sistema EOS 14.0 utilizza uno standard di comunicazione analogico. Le diverse funzioni (luminose e acustiche) sono attivate con diverse soglie di tensione in ingresso.

Connesso in rete o ad un cloud, il sistema EOS 14.0 permette il controllo e il monitoraggio a distanza di macchinari e rientra per tanto nel **programma Industria 4.0 per quanto riguarda l'Interazione Uomo - Macchina (HMI)**.

La comunicazione non è mai stata così semplice!

SIRENA

Sirena SpA | C.so Moncenisio, 5 | 10090 Rosta (TO)
T +39 011 95 68 555 | F +39 011 95 67 928
www.sirena.it | info@sirena.it



Colonne di segnalazione LED con standard di comunicazione analogico

EOS 14.0 è disponibile in diverse configurazioni, composte da uno o due moduli luminosi multicolore RGB, modulo acustico (2 livelli di resa acustica), con connessione tramite connettore M12 oppure tramite cavo.

La **tensione di alimentazione** della colonnina è di **24Vdc**: il sistema è progettato per attivare la segnalazione luminosa (5 colori in modalità luce fissa o lampeggiante) e la segnalazione acustica con **soglie di tensione in ingresso (regolabile 0-10Vdc)**, utilizzando **una sola uscita analogica del PLC**. Tramite isteresi, tutte le soglie di tensione sono protette da accensioni o cambi di colore indesiderati.

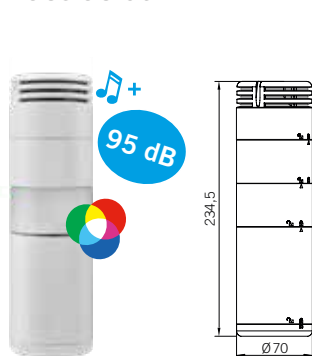

94732

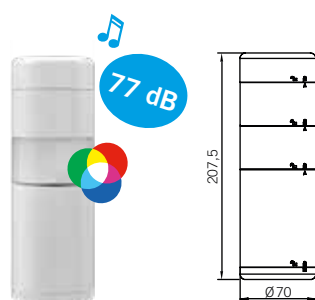

94734

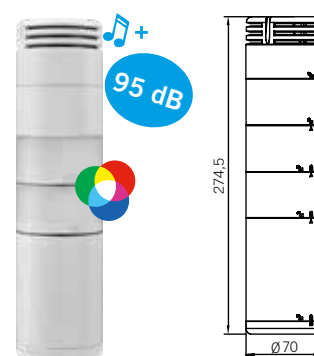

94735

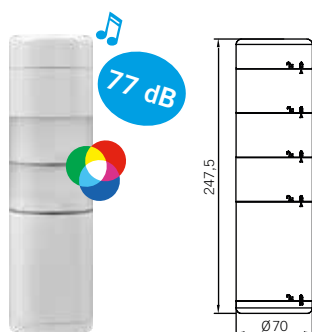

94736

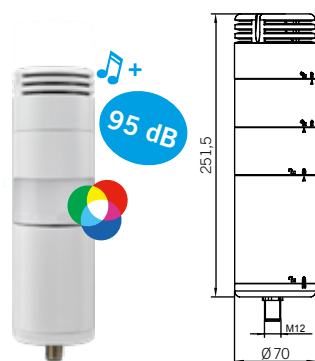

94737

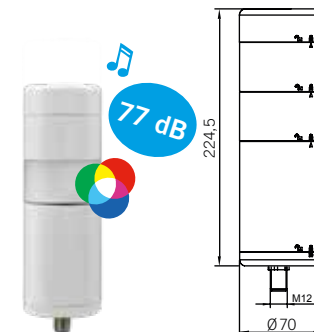

94738

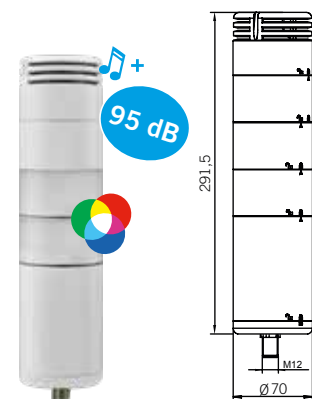

94739

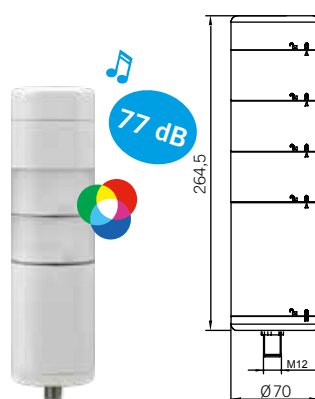

94740

EOS 14.0

LED signal stack lights with analog communication standard

#morethanbrightideas

For more information contact us or visit our website

industrial@sirena.it



EOS 14.0

The EOS 14.0 system uses an analog communication standard. The different functions (luminous and acoustic) are activated with different input voltage thresholds.

Connected to the network or to a cloud, the **EOS 14.0 system** allows remote control and monitoring of machinery and could therefore be part of the **Industry 4.0 for Human - Machine Interface (HMI)**.

SIRENA

Sirena SpA | C.so Moncenisio, 5 | 10090 Rosta (TO)
T +39 011 95 68 555 | F +39 011 95 67 928
www.sirena.it | info@sirena.it



Communication has never been easier!

LED signal stack lights with analog communication standard

EOS 14.0 is available in different configurations, consisting of one or two multicolored RGB light modules, acoustic module (2 levels of sound output), with connection via M12 connector or cable. The **supply voltage** of the column is **24Vdc**: the system is designed to activate luminous signaling (5 colors in steady or flashing light mode) and acoustic signaling with **input voltage thresholds (adjustable 0-10Vdc)**, using **only one analog PLC output**. Through hysteresis, all voltage thresholds are protected from unwanted activations or color changes.

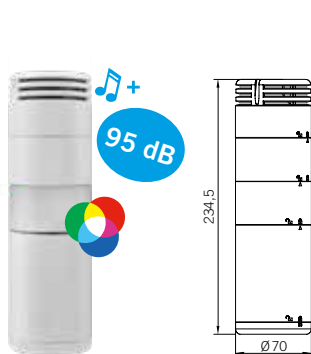

94732

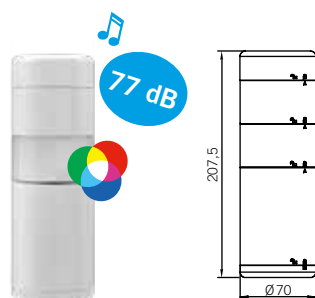

94734

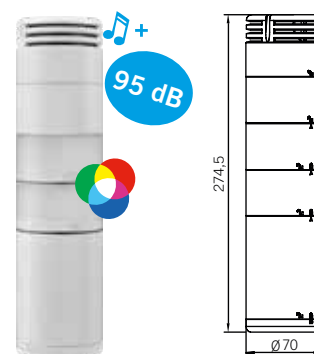

94735



94736

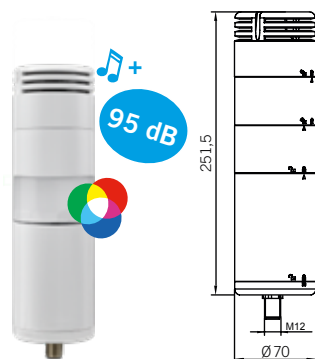

94737

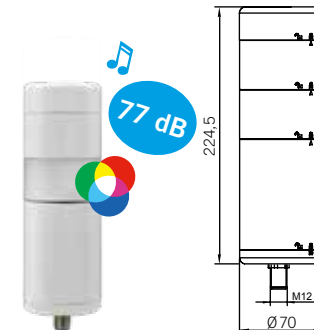

94738

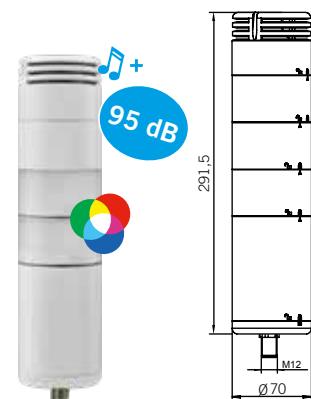

94739

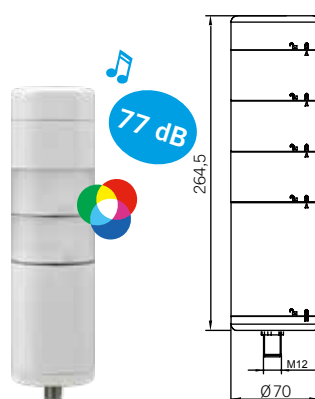

94740

EOS 14.0

Colonnes de signalisation LED avec standard de communication analogique

#morethanbrightideas

Pour en découvrir davantage, contactez-nous ou visitez notre site web

industrial@sirena.it



EOS 14.0

SIRENA

Sirena SpA | C.so Moncenisio, 5 | 10090 Rosta (TO)
T +39 011 95 68 555 | F +39 011 95 67 928
www.sirena.it | info@sirena.it



Le système EOS 14.0 utilise un standard de communication analogique. Les différentes fonctions (lumineuses et acoustiques) sont activées avec différents seuils de tension d'entrée.

Connecté au réseau ou au cloud, le **système EOS 14.0** permet le contrôle et la surveillance à distance de machines et fait partie du programme **Industrie 4.0** en ce qui concerne l'Interface Homme - Machine (HMI).

La communication n'a jamais été aussi simple !

Colonnes de signalisation LED avec standard de communication analogique

EOS 14.0 est disponible en différentes configurations, composées d'un ou deux modules lumineux multicolores RGB, module acoustique (2 niveaux de rendu acoustique), avec connexion par connecteur M12 ou par câble.

La **tension d'alimentation** de la colonne est de **24Vdc** : le système est conçu pour activer la signalisation lumineuse (5 couleurs en mode lumière fixe ou clignotant) et la signalisation sonore avec des **seuils de tension d'entrée (réglable 0-10Vdc)** en utilisant **une seule sortie analogique du PLC**. Par hystérésis, tous les seuils de tension sont protégés contre les activations ou les changements de couleur indésirables.

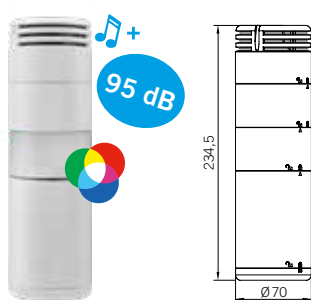

94732

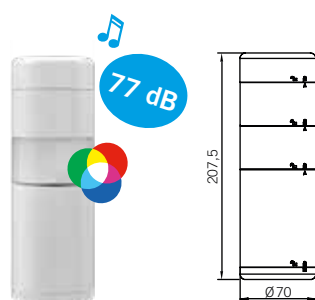

94734

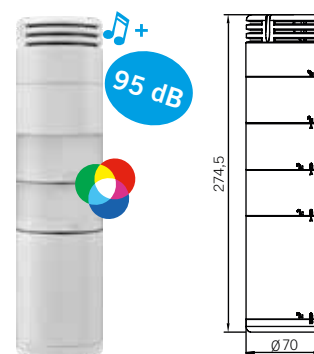

94735



94736

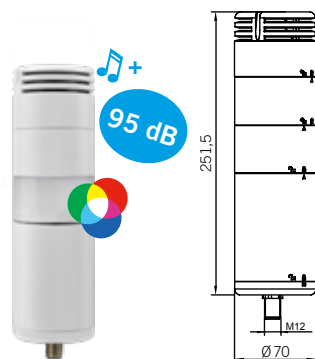

94737

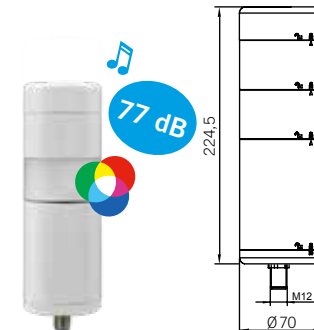

94738

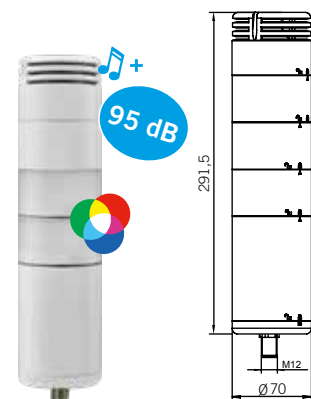

94739

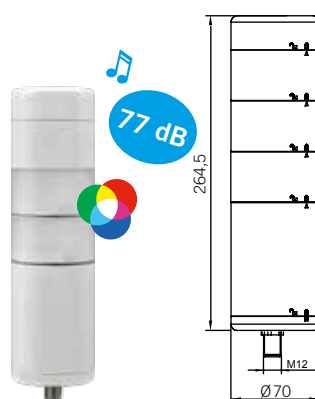

94740